

Xinger®

Ultra Low Profile 0805 Balun 50Ω to 100Ω Balanced



Description

The B0310J50100AHF is a low cost, low profile sub-miniature unbalanced to balanced transformer designed for differential inputs and output locations on modern chipsets in an easy to use surface mount. The B0310J50100AHF is ideal for high volume manufacturing and delivers higher performance than traditional wire wound baluns. The B0310J50100AHF has an unbalanced port impedance of 50Ω and a 100Ω balanced port impedance*. This transformation enables single ended signals to be applied to differential ports on modern integrated chipsets. The output ports have equal amplitude (-3dB) with 180 degree phase differential. The B0310J50100AHF is available on tape and reel for pick and place high volume manufacturing.

Detailed Electrical Specifications: Specifications subject to change without notice.

Features:	Parameter	ROOM (25°C)			Unit
		Min.	Typ.	Max	
<ul style="list-style-type: none"> • 300 – 1000 MHz • 0.7mm Height Profile • 50 Ohm to 2 x 50 Ohm • Surface Mountable • Tape & Reel • Non-conductive Surface • RoHS Compliant • Halogen Free 	Frequency	300		1000	MHz
	Unbalanced Port Impedance		50		Ω
	Balanced Port Impedance		100		Ω
	Return Loss	8.1	9.4		dB
	Insertion Loss*		0.8	1.0	dB
	Amplitude Balance		2.5	2.8	dB
	Phase Balance		34	36	Degrees
	CMRR		9		dB
	Power Handling			2	Watts
	Operating Temperature	-55		+85	°C

* Insertion Loss stated at room temperature (Insertion Loss is approximately 0.1 dB higher at +85 °C)

Outline Drawing

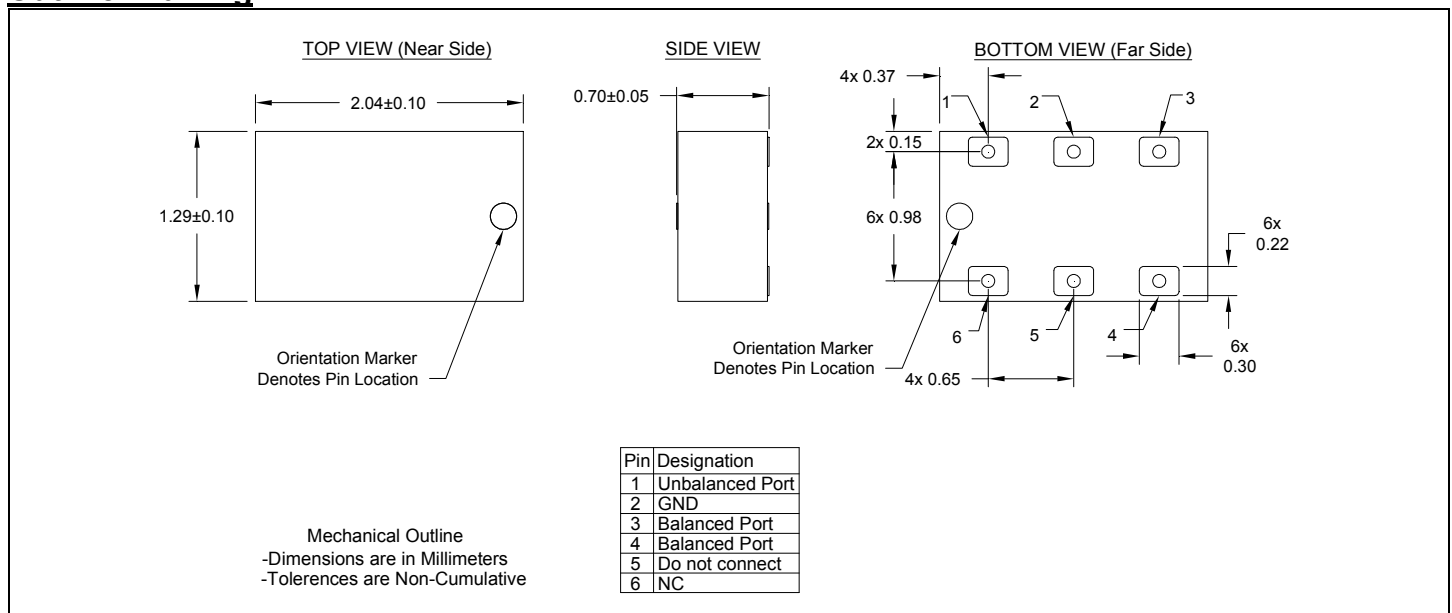

Typical Performance: 200 MHz. to 1100 MHz.

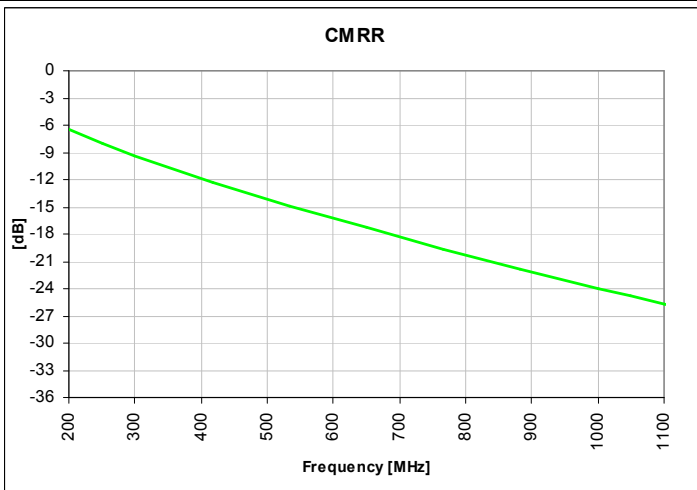
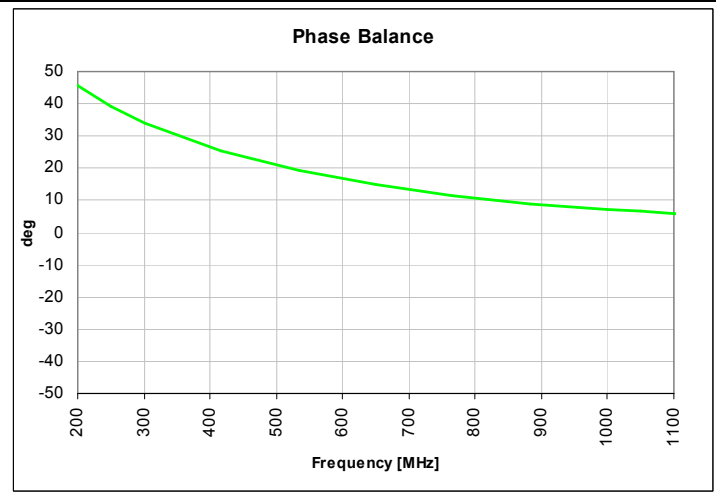
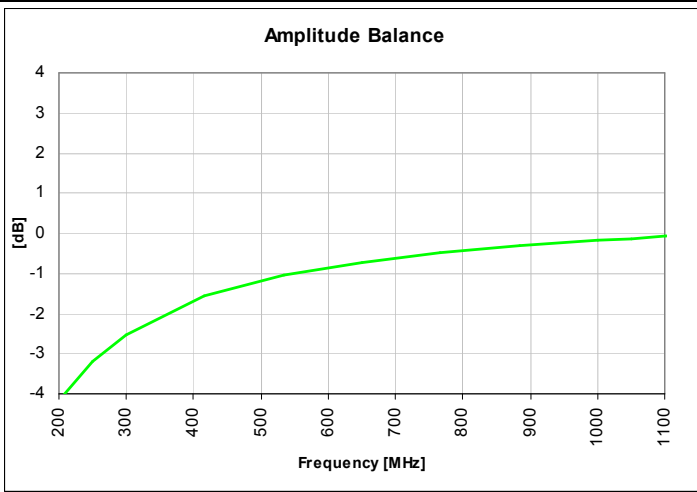
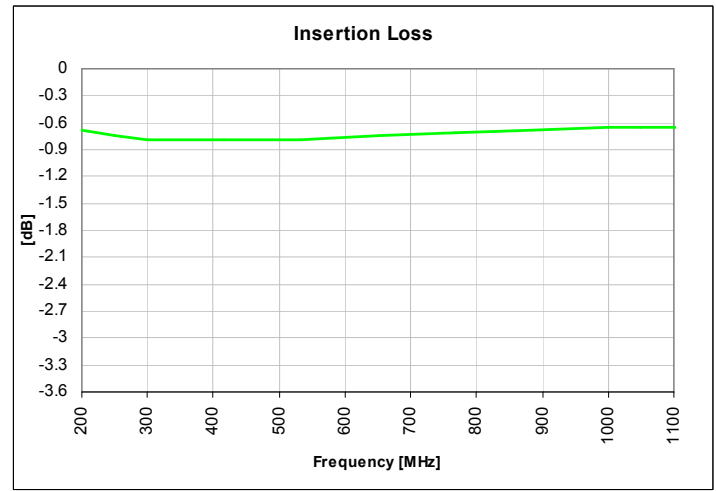
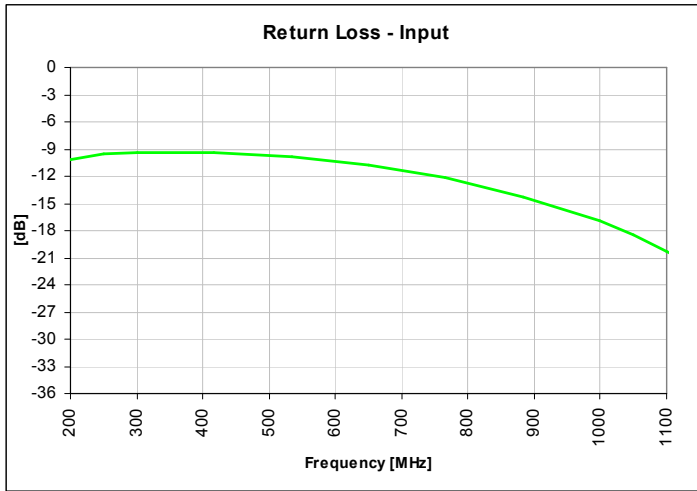

Wide Band Performance: 0 MHz. to 8000 MHz.

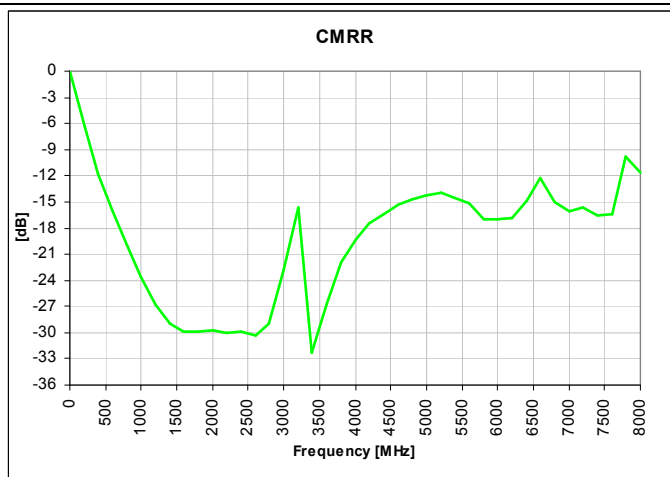
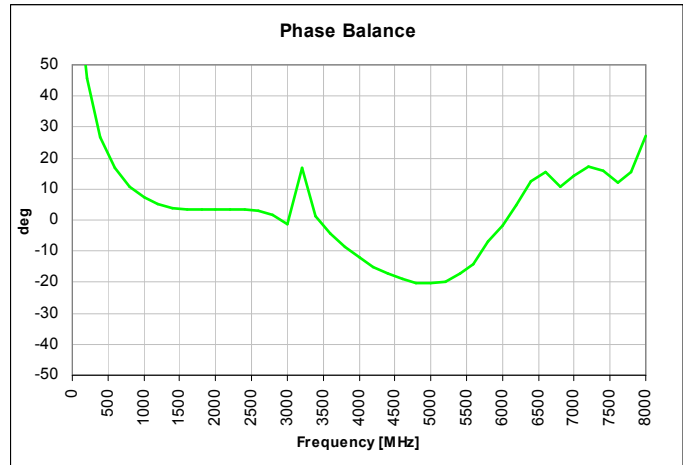
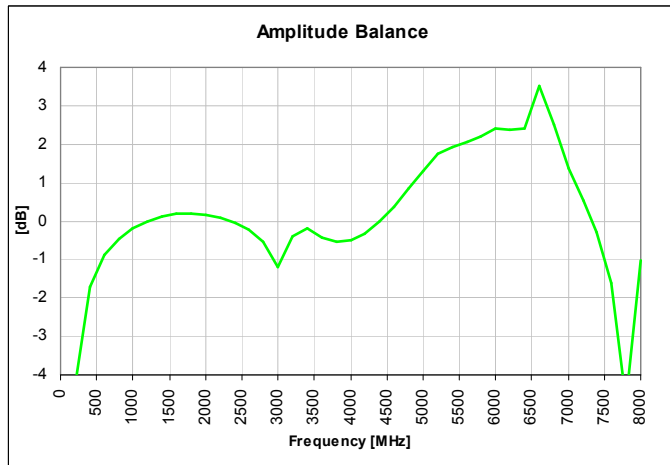
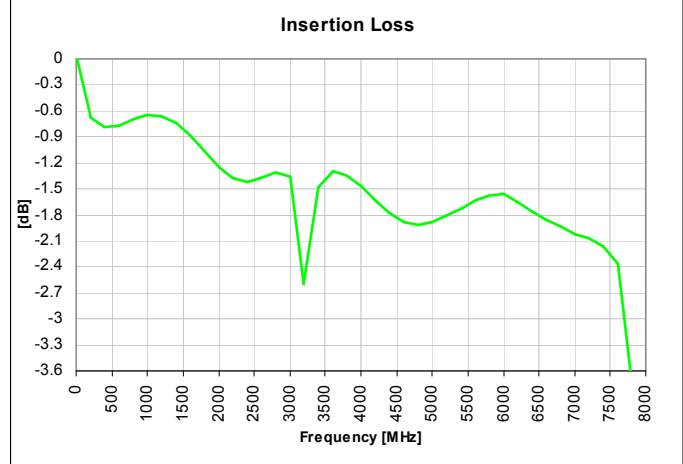
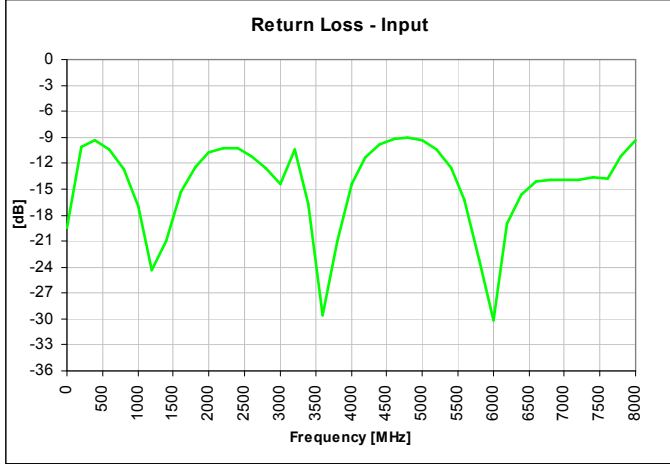



Mounting Configuration:

In order for Xinger surface mount components to work optimally, the proper impedance transmission lines must be used to connect to the RF ports. If this condition is not satisfied, insertion loss, Isolation and VSWR may not meet published specifications.

All of the Xinger components are constructed from organic PTFE based composites which possess excellent electrical and mechanical stability. Xinger components are compliant to a variety of ROHS and Green standards and ready for Pb-free soldering processes. Pads are Gold plated with a Nickel barrier.

An example of the PCB footprint used in the testing of these parts is shown below. In specific designs, the transmission line widths need to be adjusted to the unique dielectric coefficients and thicknesses as well as varying pick and place equipment tolerances.

-  Circuit Pattern
-  Footprint Pad (s)
-  Solder Resist

Dimensions are in Millimeters
Mounting Footprint

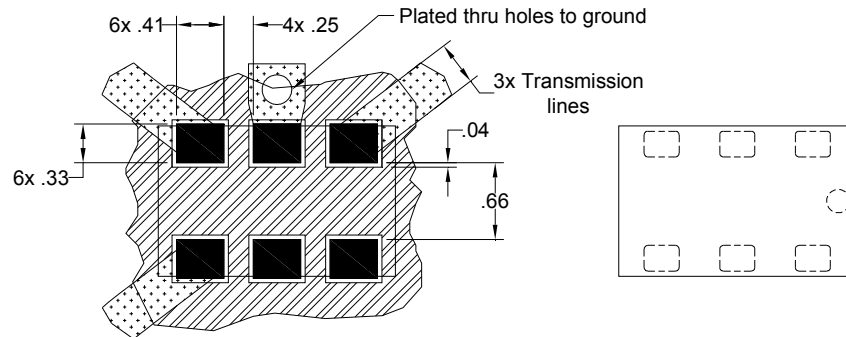

Packaging and Ordering Information

Parts are available in reel and are packaged per EIA 481-2. Parts are oriented in tape and reel as shown below. Minimum order quantities are 4000 per reel. See Model Numbers below for further ordering information.

