

Cable sleeve - CES-LTPG-GY-28 - 0801701

Please be informed that the data shown in this PDF Document is generated from our Online Catalog. Please find the complete data in the user's documentation. Our General Terms of Use for Downloads are valid (<http://download.phoenixcontact.com>)

Large, slotted cable sleeves suitable for cables with a diameter of 27 ... 28 mm, material: SEBS



Product description

Slotted sleeves for accommodating pre-assembled cables and lines with a diameter of 27 ... 28 mm, can be used in CES sealing frames. When fitted, the sleeves also ensure strain relief according to DIN EN 50262.



Key commercial data

Packing unit	0
Minimum order quantity	1
GTIN	 4 046356 675048
Custom tariff number	85472000
Country of origin	POLAND

Technical data

General data

Product description	Slotted sleeves for accommodating pre-assembled cables and lines with a diameter of 27 ... 28 mm, can be used in CES sealing frames. When fitted, the sleeves also ensure strain relief according to DIN EN 50262.
External cable diameter	27 mm ... 28 mm
Material	SEBS
Inflammability class according to UL 94	V0
Color	gray
Degree of protection	IP54
Ambient temperature (operation)	-40 °C ... 80 °C (static)

Classifications

ETIM

ETIM 3.0	EC000879
ETIM 4.0	EC000451

Cable sleeve - CES-LTPG-GY-28 - 0801701

Classifications

ETIM

ETIM 5.0	EC000451
----------	----------

UNSPSC

UNSPSC 11	39121708
UNSPSC 12.01	39121708
UNSPSC 13.2	39121708
UNSPSC 6.01	30212109
UNSPSC 7.0901	39121708

eCl@ss

eCl@ss 4.0	27081002
eCl@ss 4.1	27081002
eCl@ss 5.0	27081002
eCl@ss 5.1	27081002
eCl@ss 6.0	27081002
eCl@ss 7.0	27081002

Drawings

Cable sleeve - CES-LTPG-GY-28 - 0801701

Dimensioned drawing

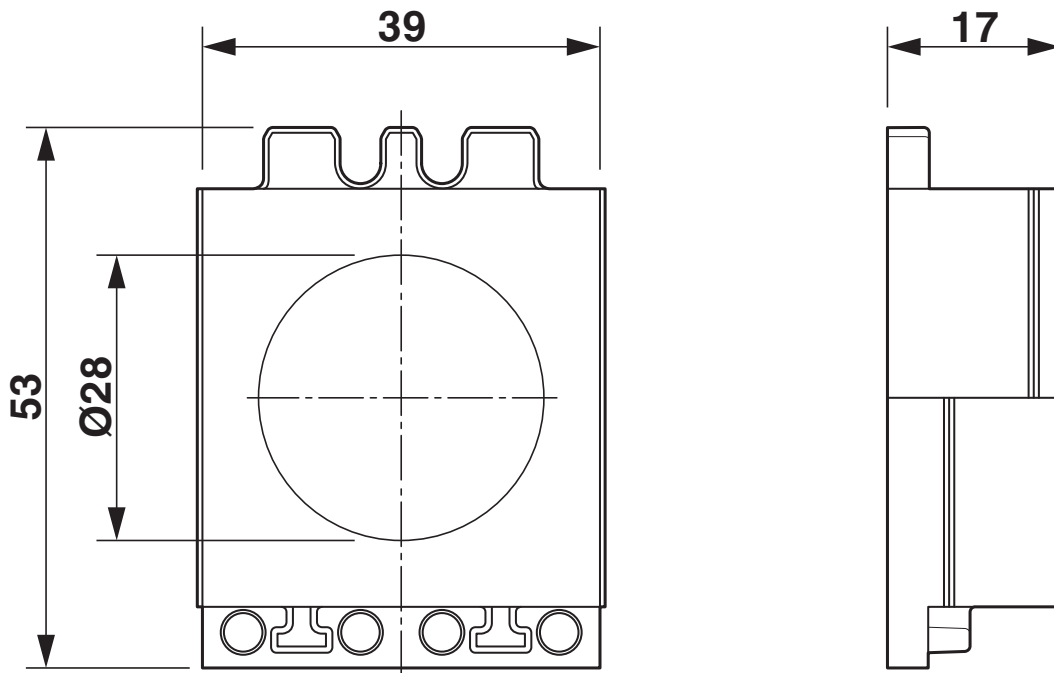

Dimensional drawing

